

THE PERFECT SOLUTION

///ATMOSEAL®



CUSTOM SIZED
TO ENSURE
A PERFECT SEAL

BACKING IS MADE
WITH THE HIGHEST
QUALITY PRESSURE
TREATED WOOD

LONG LASTING
AND LOW
MAINTENANCE

GALVANIZED STEEL
MOUNTING BRACKETS

YELLOW
GUIDE STRIPE IS
VULCANIZED
(HEAT SEALED);
NOT SEWN ON

LONG LASTING
HIGH QUALITY
VINYL WITH
U.V. STABILIZER
TO PREVENT FADING

NO STRUCTURE
TO CRUSH,
HIGH
DENSITY MEMORY
FOAM
COMPRESSES
ON ALL SIDES
REDUCING DAMAGE

SERIES 0101 STATIONARY DOCK SEAL

Designed to work best where the vehicles are generally a standard size, the 0101 is an economical way to form an air-tight seal between the building and the back-end of the trailer for dock openings up to 8'x 8'. The resilient foam pads can be covered with a large selection of tough abrasion resistant fabrics creating a tight seal that blocks out the foul weather, insect, dust and may reduce theft, while saving money on energy costs. The Series 0101 Dock Seal will increase the comfort and productivity by increasing safety, protecting personnel, products and equipment.

SUPER SEAL

Tel: 905.850.2929 Tel: 1.800.337.3239
Fax: 905.850.2922 Fax: 905.850.4440

www.supersealmfg.com

SuperSeal Mfg. Ltd.
670 Rowntree Dairy Rd.,
Woodbridge, Ontario, Canada L4L 5T8

SPECIFICATIONS

Series 0101 Product Details:

- Series 0101 standard dimensions for door openings 8' W x 8' H have (2) 8' high vertical pads and one (1) 10' long head pad with 12" face and cubed shaped. Unit projection to be 10".
- Seals trailers 12' to 13' H from grade with a dock height of 48".
- A large selection of cover fabrics available including our exclusive SS-90-1 high performance vinyl and 16 oz. vinyl "RipStop". Other fabrics and colours are available include: hypalons and vinyls (see fabric page).
- Can be fitted for openings up to 9' W x 10' H by the use of wedge shaped vertical and head pads.
- 4" maximum pad projection in front of the dock bumper face is recommended to prevent over compression, excessive wear and tear and undue building wall pressure.

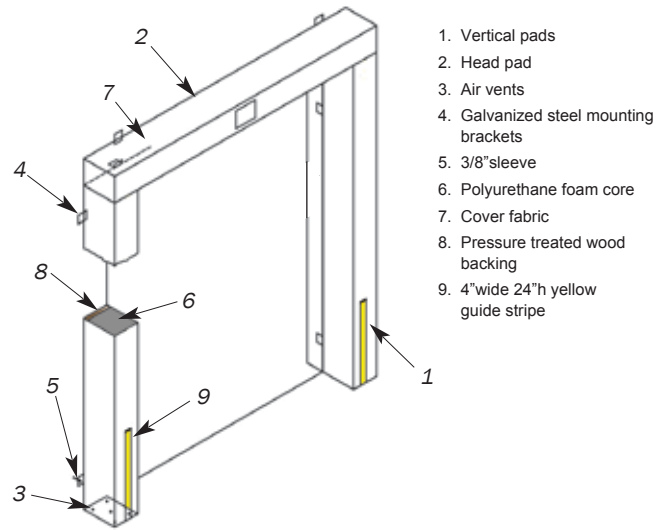

Specifications:

Dock door seal(s) to be Series 0101 as manufactured by Super Seal Mfg.Ltd., Woodbridge, Ontario. Dock door seal(s) _____ft.W x _____ft.H, using pressure treated wood, and a high density, light-weight urethane foam core with 98% compression recovery and maintaining flexibility at -40 degrees. The foam core shall be continuously bonded (not spot glued) to the wood backing with a high quality, non-flammable elastic adhesive. Cover fabric overlaps the wood backing, totally enclosing it, and is fastened with heavy duty plated staples. All foam pads are vented through holes allowing air to be exhausted and moisture to drain when pads are compressed. Vertical pads are tapered cut at the bottom to prevent sagging, pinching, and wearing when compressed. Vertical pads have a 24" h or optional full height 4" yellow guide stripe to aid in spotting trailers. Unit shall be furnished with all necessary galvanized mounting hardware to resist corrosion.

Options:

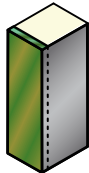

A. Cover material overlaps edges only.

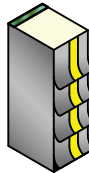

B. Protective flaps (4", 8", 16" exposure).

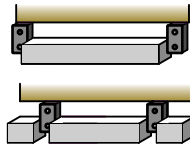

C. Bottom pads.

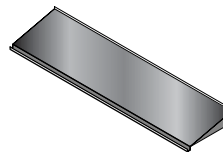

D. Galvanized steel canopy.

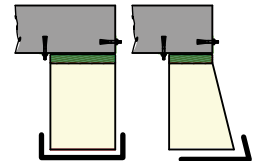

E. Double layer of fabric on impact area.



F. Touch and hold velcro drop curtain (12"-18" drop).



G. Beveled vertical pads (8/11 - 12/15 - 12/18).

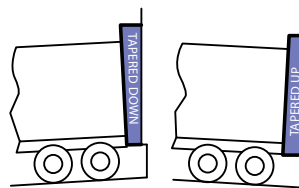

H. Tapered units.

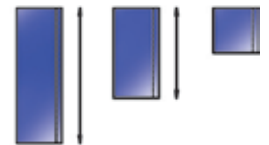

I. Higher head pad (up to 24" H).



Custom Designs Available!

DEALER IMPRINT



** All Super Seal products are subject to design modifications without notice. Product may be shown with non-standard options.